

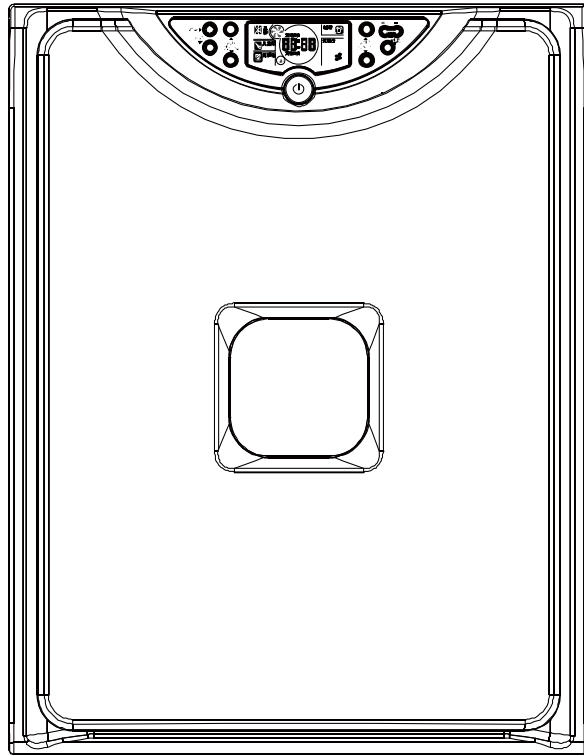

## WHYNTER Eco Pure Air Purifier

MODEL# : AFR-300

### Instruction Manual



Thank you for your purchase of this WHYNTER product. Please read this Instruction Manual carefully before using the product to ensure optimal performance. Keep this manual in a safe place for future reference.

## **TABLE OF CONTENTS**

---

Important Safety Instructions.....	3
Purification Technology.....	4
Technical Data.....	5
Parts and Features .....	6
Control Panel & Remote Control.....	7-9
Installation .....	10
Care and Maintenance.....	10-12
Troubleshooting.....	13
Warranty .....	14



## Important Safety Instructions

To reduce the risk of fire, electrical shock, or injury when using your appliance, follow these basic precautions:

1. Place the appliance on hard and level surface where it can not be easily knocked down.
2. Do not use if the power supply cord is damaged. If damaged, it must be replaced by a qualified electrician.
3. This appliance is not intended for use by young children or physically-challenged persons without supervision/assistance. Young children must be supervised to ensure safety around this or any appliance.
4. Always switch off and unplug the appliance when replacing filters, cleaning, moving, or when not in use.
5. Keep the appliance away from any heat source, direct sunlight or area with excessive moisture such as bathrooms and kitchens.
6. This air purifier is an electrical appliance. To avoid injury from electrical shock do not operate the appliance with wet hands, while standing on a wet surface or while standing near in water. Do not use outdoors or in wet conditions.
7. Avoid placing any objects on top of the appliance.
8. Never pull the cord to disconnect it from the power outlet. Grasp the plug and pull it from the outlet.
9. Never lift or carry the appliance by the power cord.
10. This appliance is designed for household, non-commercial use only. Any other use will void the warranty.
11. Do not try to disassemble, modify or repair the appliance by yourself.
12. Do not place the appliance upside down or on its side.
13. Do not block the air intake and air outlet.
14. When positioning the appliance, ensure that there is at least a 6" clearance around the appliance. This allows for adequate ventilation.
15. If used with a humidifier, please keep this appliance away from the humidifier.
16. Never use harsh detergents or solvents to clean the appliance.
17. Do not operate the appliance without installing the filters.
18. Do not wash and reuse the Whynter HEPA filter. HEPA filters should only be replaced, not cleaned.

This AFR-300 air purifier utilizes a complete 5-layer purification system which includes a Pre-filter, HEPA filter, Activated carbon filter, Photo-catalyst filter and UV light. The AFR-300 air purifier not only traps dust and dirt, it also destroys allergens such as dust mites, pollen and pet epithelia. It kills over 99% of viruses, over 98% of bacteria and over 94% of mold and fungus.

The conveniently compact size allows the Whynter Eco Pure air purifier to be moved from room to room or from a home to the office as needed. With an effective range of 600 square feet, it is powerful enough to clean the air in any room.

## Purification Technology

**Pre-filter:** The washable pre-filter filtrates large size allergens, dust and pet hair.

**HEPA filter:** HEPA stands for High Efficiency Particulates Air. The Whynter HEPA filter is designed to remove 99.97% of all allergens such as bacteria, pollen, pet dander, dust mite that are 0.3 microns or larger. (For reference, 1 micron is 1/100<sup>th</sup> of the width of human hair.) Once the allergens are “trapped” by the HEPA filter, they are not released back into the air.

**Activated carbon filter:** The washable activated carbon filter absorbs and removes common household odors VOCs (volatile organic compound), chemical smells and cigarette odor.

**Ultraviolet (UV) light:** Sterilizes airborne pathogens like germs, viruses and bacteria that are too small to be captured by the HEPA filter.

**Photo-catalyst filter:** Photo-catalyst (TiO<sub>2</sub>) filter uses ultra violet light to breakdown harmful gases in removing both particulate and gas contaminants from air. It purifies, sterilizes and deodorizes air. It kills harmful bacteria thoroughly, decomposes organic compounds (methanal, benzene, etc.) and inorganic compounds (nitrogen oxide, sulphide, etc.), and inhibit mildew. It also has self-cleaning ability.

## Technical Data

Model no.	AFR-300
Coverage Area	600 Sq. Ft.
Voltage	120v / 60Hz
Purification efficiency	>99.97%
Input power	76 Watts
Noise level (at lowest setting)	<35dB
Fan Speed	4 adjustable speed
Air flow	250 Square Meter per Hour Max. / 147 Cubic feet per minute Max.
Net weight	16.5 lbs
Product size(WxHxD)	16" x 8.3" x 29.7"

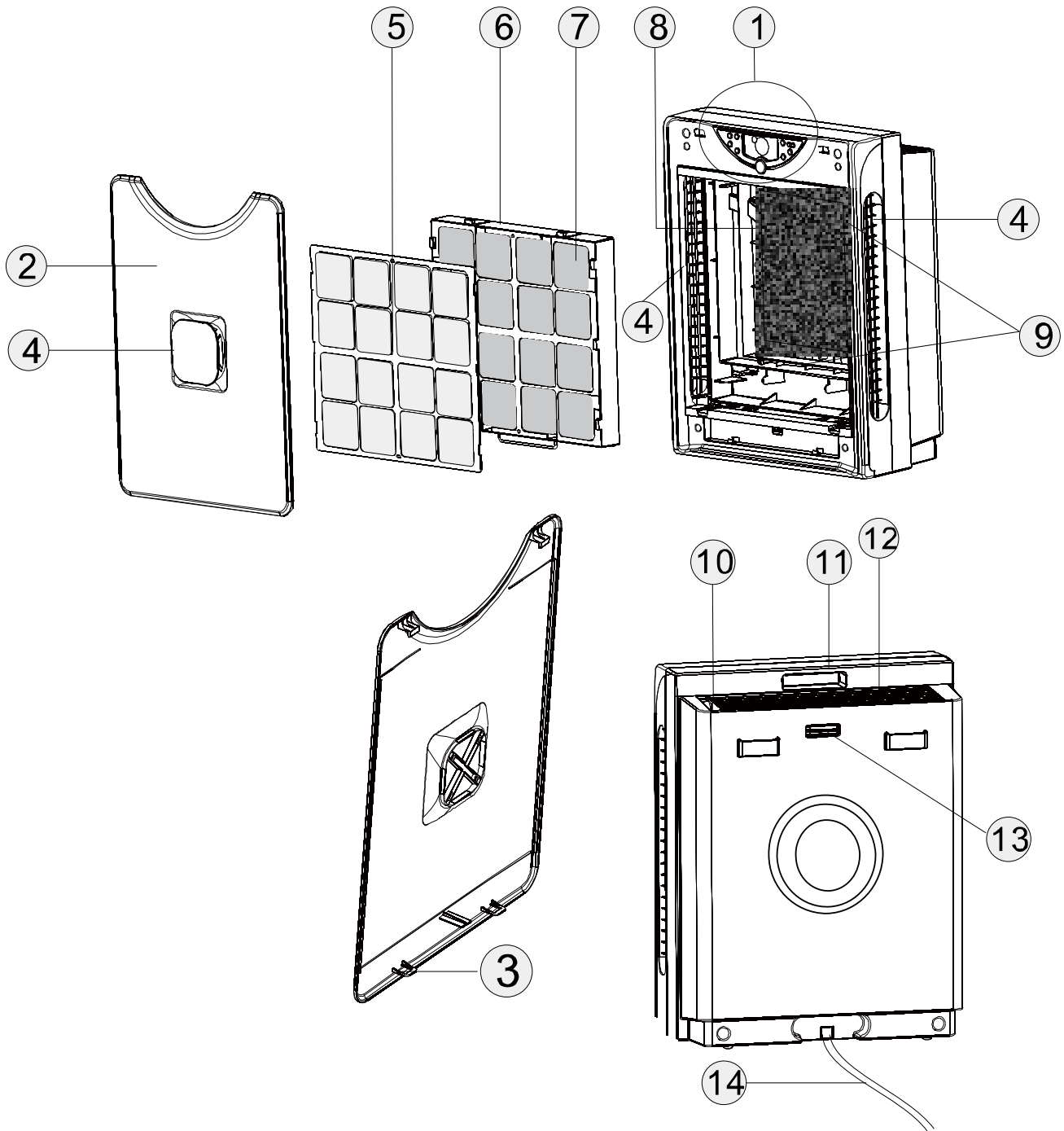

## PARTS OVERVIEW

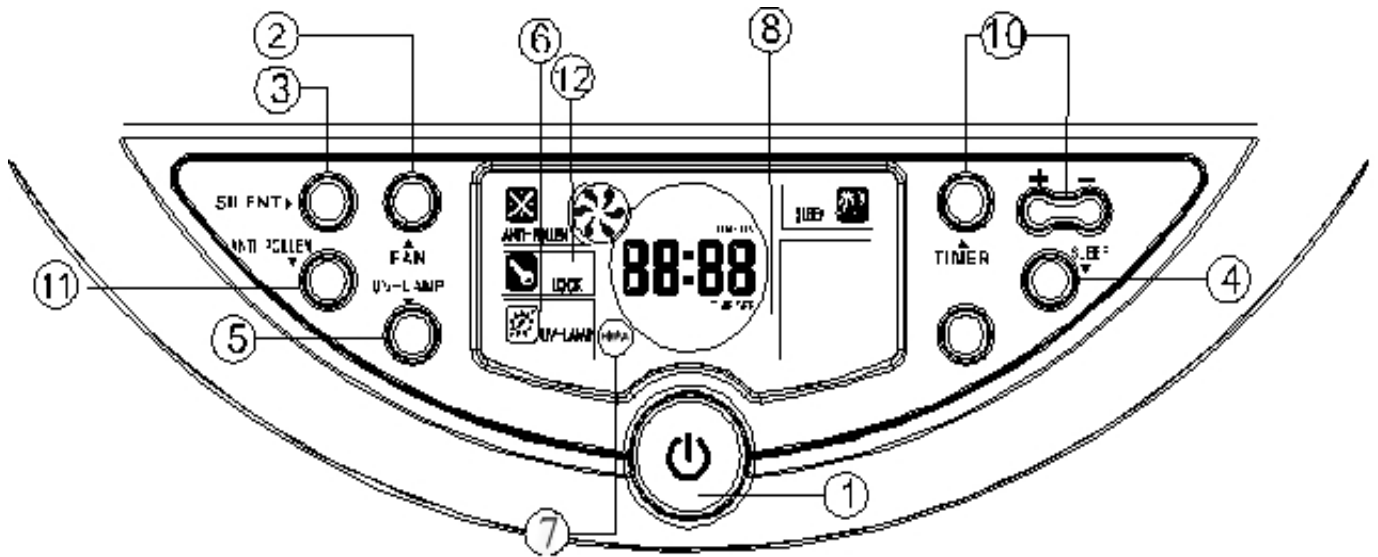

1. Control Panel	2. Front Cover	3. Front Cover Clip	4. Air Intake Vents	5. Pre-filter
6. Filter Frame	7. HEPA Filter & Activated Carbon Filter	8. Photo-catalyst Filter	9. UV Lamp	10. Remote Control holder
11. Handle	12. Air Outlet Vent	13. Fragrance Diffuser	14. Power Cord	

## CONTROL PANEL & REMOTE CONTROL



1. ON/OFF: Turns on / off the air purifier.
2. FAN: Sets fan speed setting in the cycle of High → Medium → Low → Silent.
3. SILENT: Sets the air purifier to run at a noise level below 35 dB to ensure sound sleep. By pressing this button, this machine will be switched into the “SILENT” fan mode.
4. SLEEP: Sets running time of the air purifier at SILENT mode for 8 hours. In the SLEEP mode, the TIMER function cannot be used.
5. UV Lamp: Turns on / off the photo-catalyst POC function.
6. UV Lamp indicator *on LCD display*: When the UV lamp is on, the screen displays , the sun icon. When the screen displays , it indicates that the UV lamp needs to be replaced. The working life of a UV lamp is about 15,000 hours.
7. HEPA filter replacement indicator: When the HEPA filter replacement indicator blinks on the LCD display, you need to change a new HEPA filter.
8. LED: The background of the LED light can be turned on and off.
9. Intentionally removed.
10. TIMER: By pressing “TIME” button once, “88:88” will be displayed, press the “+” & “-” buttons to set the current time. When the air purifier is turned on, press the “TIME” button twice quickly, “88:88<sub>time off</sub>” will be displayed, then press the “+” & “-” buttons to adjust the time off. When the machine is on Standby mode, press the “TIME” button twice quickly, “88:88<sub>time on</sub>” will be displayed, then press the “+” & “-” buttons to adjust the activation time.
11. ANTI-POLLEN: Turns on the pollen-removing function. This mode of operation is recommended for pollen season. The fan speed will run in a cycle of medium speed for 5 minutes and low speed for 5 minutes.

## REMOTE CONTROL OPERATION

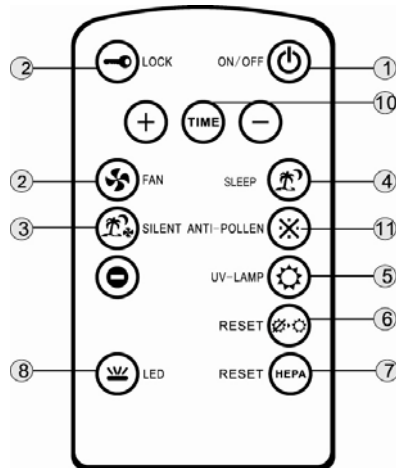

1. ON/OFF: Turns on / off the air purifier.
2. LOCK: Press the “LOCK” (No. 2) button on remote control to lock the air purifier. All the buttons on the air purifier and the remote control are disabled except the “LOCK” button on the remote control. To unlock the air purifier, press this button again. You can also unplug and restart the air purifier.
2. FAN: Sets fan speed setting in the cycle of High → Medium → Low → Silent.
3. SILENT: Sets the air purifier to run at a noise level below 35 dB to ensure sound sleep. By pressing this button, this machine will be switched into the “SILENT” fan mode.
4. SLEEP: Sets running time of the air purifier at SILENT mode for 8 hours. In the SLEEP mode, the TIMER function cannot be used.
5. UV Lamp: Turns on / off the photo-catalyst POC function.
6. UV Lamp timer reset: If the UV Lamp is replaced, press the RESET button to set the timer to zero.
7. HEPA filter timer reset: After the HEPA filter is replaced, press the RESET button to set the timer to zero.
8. LED: Turns on / off the background LED light.
9. Intentionally removed.
10. TIMER: By pressing “TIME” button once, “88:88” will be displayed, press the “+” & “-” buttons to set the current time. When the air purifier is turned on, press the “TIME” button twice quickly, “88:88<sub>time off</sub>” will be displayed, then press the “+” & “-” buttons to adjust the time off. When the machine is on Standby mode, press the “TIME” button twice quickly, “88:88<sub>time on</sub>” will be displayed, then press the “+” & “-” buttons to adjust the activation time
11. ANTI-POLLEN: Turns on the pollen-removing function. This mode of operation is recommended for pollen season. The fan speed will run in a cycle of medium speed for 5 minutes and low speed for 5 minutes.



- The remote control is loaded with a CR2025 battery in advance. Before use, please pull off the battery insulating plastic.
- Aim the emitter of the remote control to receiver in the front of the air purifier. The maximum signal transmission distance is approximately 15 feet.
- Please change the battery if the signal is weak or if the remote control is non-responsive.

## INSTALLATION

1. The best location to install the air purifier is opposite a window or a door, this creates optimal air circulation within the room.
2. If it is used in an air-conditioned room, place the air purifier opposite the air conditioner, this creates optimal air circulation within the room.

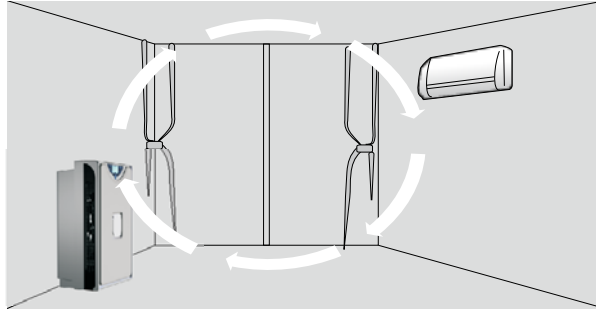

3. Keep a distance of at least 3 feet of space between the air purifier and any equipment which emits electric waves such as televisions, radios or wave clocks.
4. Ensure that there is at least a 6" clearance around the appliance. This allows for adequate ventilation.

## CLEANING & MAINTENANCE

To maintain the performance of the air purifier, regular cleaning of the unit and filters is recommended.

### ► Cleaning the pre-filter

front cover

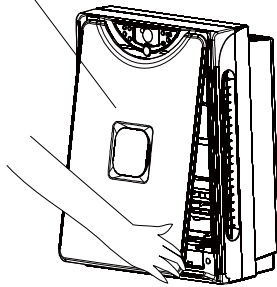

Prefilter

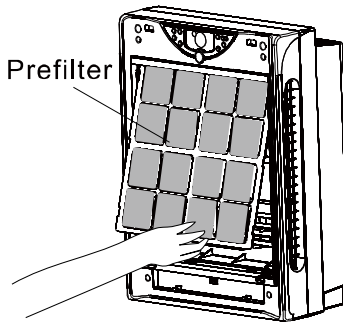

The pre-filter should be cleaned at least once a month.

- Turn off and unplug the air purifier.
- Remove the front cover and take out the pre-filter as shown in above pictures.
- Rinse the pre-filter in warm water. Do not wash it in a washing machine or dish washer. Do not use water hotter than 100F degree.
- When the pre-filter is completely dry, place it back to the air purifier.

### ► Replacing HEPA filter

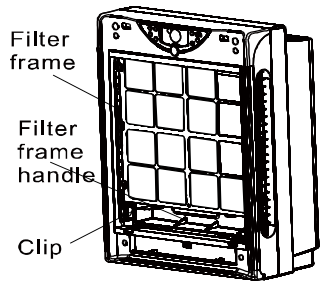

Composite filter

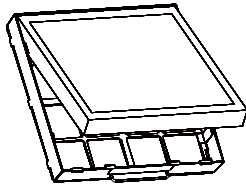

- The HEPA filter needs to be replaced every 2,000 working hours or when the HEPA icon flashes on the LCD display. The higher level of pollutants, the shorter the lifespan of the filter.
- Remove the front cover, the pre-filter and the old HEPA filter.
- Install the new HEPA filter with the arrow in the front to the air purifier.
- Press the HEPA “RESET” button on the remote control to reset the HEPA filter timer.
- Dispose of the old HEPA filter and do not reuse.

### ► Cleaning the photo-catalyst filter

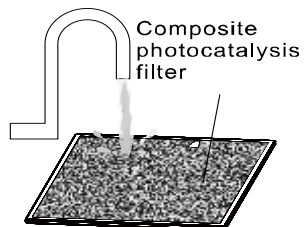
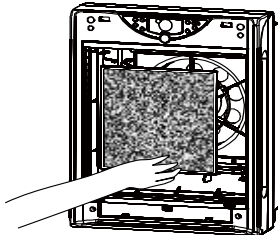

The photo-catalyst filter should be cleaned every 6 months depending on the air quality.

- Remove the front cover, pre-filter and HEPA filter as shown in the above picture.

- Remove the photo-catalyst filter and use a vacuum cleaner with a nozzle or brush attachment on lower power setting to clean the dirt and dust from the filter.

► **Replacing the UV Lamp**

The UV lamp should be replaced every 15,000 working hours. This is indicated by the blinking of the UV icon on the LCD display. Please contact Whynter's service department for purchase information of a new UV lamp.

► **Cleaning the front cover**

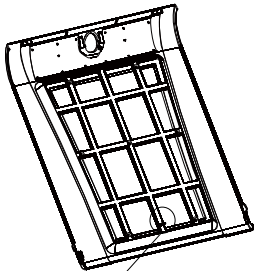

Extruding block

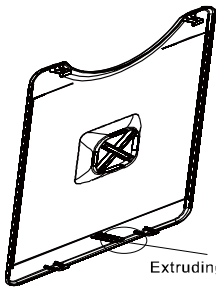

Extruding block

The surface of the air purifier should be cleaned at least once a month or more often depending on the air quality.

- Remove the front cover from the air purifier.
- Use a clean, dry cloth to wipe the external surfaces.
- Use a damp cloth to remove stubborn stains and dirt build up.
- Clean the air inlets and outlet with a dry cloth or a vacuum cleaner.
- When dismantling or mounting the front cover, please be careful not to break the hinge at the bottom of the front cover, otherwise this unit can not be turned on. The block is a safety device which automatically cuts power off when the front cover is opened.

## TROUBLESHOOTING

Trouble	Check list	Solution
Unit does not start	There is a power supply failure	Ensure that the air purifier is plugged in and the power outlet has power
	The front cover is installed properly	Install the front cover properly
Remote control does not work	The Child lock may be on	Turn off the Child lock
	The remote control has no power	Replace battery in the remote control
	The remote control signal is obstructed	Point the remote control directly towards the front of the air purifier
The air purifier is noisy and vibrates	The unit is not level	Ensure the unit sits on a hard and level surface. Do not place the unit on carpet.
Odor and smoke are not removed	Filters are dirty	Clean or replace filters
	The unit is unable to circulate air	Install unit in a place where air is able to circulate
Air does not flow from the unit	Air inlets maybe obstructed	Ensure the air inlets are not obstructed
The filter replacement indicator remains on after the filter is replaced	Unit is not reset	Press the reset button on the remote control
	Unit needs to be restarted	Restart the unit by unplugging it

## **ONE YEAR LIMITED WARRANTY**

This WHYNTER air purifier is warranted, to the original owner within the 48 continental states, for one year from the date of purchase against defects in material and workmanship under normal use and service. Should your WHYNTER air purifier prove defective within one year from the date of purchase, return the defective part or unit, freight prepaid (within two months of purchase; after two months to one year, customer will be responsible for freight cost to Whynter's service department), along with an explanation of the claim to Whynter LLC. Please package the air purifier carefully in its original packaging material to avoid damage in transit. Please retain the original box and packaging material. Under this warranty, Whynter will repair or replace any parts found defective. This warranty is not transferable. After the expiration of the warranty, the cost of labor and parts will be the responsibility of the original owner of the unit.

### THIS WARRANTY DOES NOT COVER:

- Filters
- Acts of God, such as fire, flood, hurricanes, earthquakes and tornadoes.
- Damage, accidental or other wise, to the air purifier while in the possession of a consumer not caused by a defect in material or workmanship;
- Damage caused by consumer misuse, tampering, or failure to follow the care and special handling provisions in the instructions.
- Damage to the finish of the case, or other appearance parts caused by wear.
- Damage caused by repairs or alterations to the air purifier by anyone other than authorized by the manufacturer.
- Freight and Insurance cost for the warranty service.

To obtain service or information, contact

Whynter LLC via Email at [service@whynter.com](mailto:service@whynter.com) or

call 866-WHYNTER.